

9.31, 9.33, 9.35 Treadmill

Warning: This service manual is for use by Precor trained service providers only. If you are not a Precor Trained Servicer, you must not attempt to service any Precor Product; Call your dealer for service.

This document contains information required to perform the majority of troubleshooting, and replacement procedures required to repair and maintain this product.

This document contains general product information, software diagnostic procedures (when available), preventative maintenance procedures, inspection and adjustment procedures, troubleshooting procedures, replacement procedures and electrical block and wiring diagrams.

To move directly to a procedure, click the appropriate procedure in the bookmark section to the left of this page. You may “drag” the separator bar between this page and the bookmark section to change the size of the page being viewed.

Section One - Things you Should Know

About This Appendix

Section One, Things You Should Know. This section includes technical specifications. Read this section, as well as the 9.31, 9.33 or 9.35 Treadmill Owner's Manual, before you perform the maintenance procedures in this manual.

Section Two, Software Features. Precor treadmills are programmed with several diagnostic and setup features. This section contains the procedures you need to access the diagnostic features on this treadmill.

Section Three, Checking Treadmill Operation. This section provides you with a quick way of checking treadmill operation. Check treadmill operation at the end of a maintenance procedure and when it is necessary to ensure that the treadmill is operating properly.

Section Four, Inspection and Adjustment Procedures. Perform inspection procedures when a trouble symptom points to a particular problem and after removing and replacing major components. Many maintenance problems can be fixed by adjusting various treadmill components. This section also provides you with the step-by-step procedures required to make these adjustments.

Section Five, Troubleshooting Procedures. The diagnostic and troubleshooting procedures contained in this section should be performed when it is necessary to isolate a problem to a particular component.

Section Six, Replacement Procedures. When a treadmill component must be replaced, go to this section and follow the step-by-step procedures required to remove and replace the component.

Section Seven, Technical Diagrams and Parts Lists. This section includes wiring diagrams, and block diagrams for the 9.31, 9.33 and 9.35 Treadmill.

General Information

For the latest exploded view diagram, part number and part pricing information, visit the Precor dealer website at "www.precor.com/Dealer".

Technical Specifications

Physical Specifications

Length:	79 inches (201 cm.)
Width:	33.5 inches (85 cm.)
Height:	55 inches (140 cm.)
Running surface:	20 inches by 57 inches (51 cm. by 145 cm.)
Motor:	2.75 (9.31, 9.33), 3.0 (9.35) hp. continuous duty
DC	
Speed:	0.5 to 11 mph (0.8 to 18 kph) 10 mph is equivalent to a 6 minute mile
Incline:	0% to +15% grade
Power:	120 Vac 50/60 Hz @ 20 amp
Weight:	280 lbs (127 kg.)

Procedure 2.1 - Accessing the Hardware Validation Program

The treadmill's diagnostic program consists of the following modes:

- Display Test
- Keyboard Test
- Heart Rate Test
- Lift Test
- Belt Speed Test
- Belt Power Test

Procedure

1. Plug the power cord into the wall outlet, then turn on the treadmill with the circuit breaker.
2. Press keys **RESET,5,1,7,6,5,7,6,1**, sequentially.
3. If you are testing a 9.33 or 9.35 treadmill continue with step 4. If you are testing a 9.31 treadmill skip to step 31.
4. The keys on the display are hypothetically numbered 1 to 7 from left to right. See Diagram 2.1. The **STOP** is key number 4 and is located directly below the **QUICK START** key. The **QUICK START** key is not part of the numbering sequence.
5. The display will momentarily read **DIAGS - HARDWARE VALIDATION**.
6. The display will momentarily read **DISPLAY TEST** and then illuminate every LED on the display. Check all LED positions to ensure that all of the LED's are functioning. Press the **ENTER** key to continue.

Diagram 2.1 - 9.33 & 9.35 Displays



7. The display will momentarily read **KEYBOARD TEST**.
 8. The keyboard test will place two dots on the display for each key on the display, including the numeric keypad. Pressing a key will cause the upper of the two dots associated with the key to go out. Test all of the keys in this manner. Tug on the safety key lanyard, to ensure that the **STOP** key is activated.
 9. Press and hold the **ENTER** key to proceed to the heart rate test.
 10. The display will momentarily read **HEART RATE TEST**.
 11. The heart rate test will display the heart rate being received during this test from either a chest strap transmitter or test transmitter.
 12. Three heart rate values will be displayed. They will be prefixed “U” for unfiltered, “F” for filtered and “P” for Polar filtering. The Polar filtered heart rate will also appear in the normal heart rate display, since Polar filtering is the filtering used during normal operation. The right most red LED in the smart rate display will flash each time a heart beat is detected.
- Note:** If there is not a heart rate receiver installed or there is a bad or intermittent connection between the heart rate receiver and the upper PCA, the messages in step 9 will be replaced by the message **NO HEART RATE RECEIVER**.
13. Press the **ENTER** key to proceed to the lift test.
 14. The display will momentarily read **LIFT TEST**.
 15. Two numbers will be displayed, the percent of lift and A/D number related to the current lift position. The A/D (analog to digital) number represents the lift potentiometer reading. The A/D number will be in the range of 0 to 255.
 16. The lift may be operated using the **INCLINE** keys. The incline percentage and A/D numbers will change accordingly.
 17. The A/D reading will be used later in this service manual to calibrate the lift.
 18. Press the **ENTER** key to proceed to the belt speed test.
 19. The display will momentarily read **BELT SPEED TEST**.
 20. The speed of the running belt is controlled by the **SPEED** keys during this test.
 21. The following values are displayed; time (that the running belt has operated during this test), current (in amps through the drive motor), belt speed (in MPH) and power bits (PWM value).
 22. This test is valuable in diagnosing treadmill load conditions such as running bed and/or running belt condition. As load is increased, the speed is kept at a constant value (as set via the **SPEED** keys) and the current and power bits will vary proportionately to the load.

23. It is suggested that you perform this test on a treadmill known to be in excellent operating condition. Note the values displayed at a fixed speed (such as 3 MPH) and your body weight. Those values may then be used to benchmark the operation of treadmills you are diagnosing.
24. Press the **ENTER** key to proceed to the belt power test.
25. The display will momentarily read **BELT POWER TEST**.
26. The belt power test is similar to the belt speed test except that the **SPEED** keys control the power bits (PWM value) instead of the belt speed.
27. The same (see step 16) values will be displayed as in the belt speed test.
28. This test is valuable in diagnosing treadmill response to load conditions. As load is increased, the power bits are kept at a constant value (as set via the **SPEED** keys) and the current and belt speed will vary proportionately to the load.
29. It is suggested that you perform this test on a treadmill known to be in excellent operating condition. Note the values displayed at a fixed power bit reading (as set by the **SPEED** keys) and your body weight. Those values may then be used to benchmark the operation of treadmills you are diagnosing.
30. The belt power test is the last test in the diagnostics routine. Press the **RESET** or the **ENTER** key to exit the diagnostics routine.

Diagram 2.2 - 9.31 Display

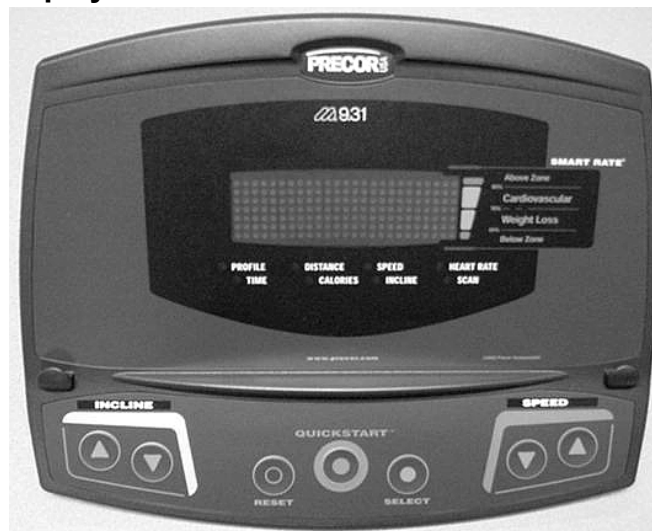

31. The keys on the display are hypothetically numbered 1 to 7 from left to right. See Diagram 2.2. **QUICK START** is key number 4.
32. The display will momentarily read **DISPLAY TEST**.

33. All of the LED's on the display will illuminate. If any LED on the display is not illuminated, replace the upper PCA.
34. Press the **SELECT** or the **RESET** key to continue to the keyboard test.
35. The display will momentarily read **KEYBOARD TEST**.
36. An indicator will be displayed for each key on the keyboard. When a key is pressed the indicator will change. Press every key on the keyboard to ensure that all keys are functioning normally.
37. Press and hold the **RESET** or **SELECT** key to continue to the heart rate test.
38. If the 9.31 is not equipped with the heart rate option, the message **NO HR RECEIVER** will be displayed indicating that a heart rate receiver was not detected.
39. Create a heart rate signal using either a heart rate chest strap or test transmitter. The heart rate LED will flash and the heart rate reading will be displayed. The **SELECT** key will allow you to toggle between **P** - Polar filtering, **U** - unfiltered and **F** - filtered.
40. Press the **RESET** key to continue to the lift test.
41. The display will momentarily read **LIFT TEST** then **A/D**.
42. The lift A/D (analog to digital) number will be displayed. The lift A/D number is related to the current lift position and represents the lift potentiometer reading. The A/D number will be in the range of 0 to 255.
43. The lift may be operated using the **INCLINE** keys. The lift A/D number will change accordingly.
44. The A/D reading will be used later in this service manual to calibrate the lift.
45. Press the **RESET** key to proceed to the belt speed test. Press **SELECT** to display the percent of incline.
46. The display will momentarily read **BELT SPEED TEST** then **MPH**. The display then show the actual operating speed.
47. The speed of the running belt is controlled by the **SPEED** keys during this test as it would be in a normal operating mode.
48. The **SELECT** key will toggle between a **MPH**, **POWERBITS** and **TIME** display. **TIME** indicates the test's elapsed time.
49. This test is valuable in diagnosing treadmill load conditions such as running bed and/or running belt condition. As load is increased, the speed is kept at a constant value (as set via the **SPEED** keys) and the current and power bits will vary proportionately to the load.

50. It is suggested that you perform this test on a treadmill known to be in excellent operating condition. Note the values displayed at a fixed speed (such as 3 MPH) and your body weight. Those values may then be used to benchmark the operation of treadmills you are diagnosing.
51. Press the **RESET** key to proceed to the belt power test.
52. The display will momentarily read **BELT POWER TEST** then **POWERBITS**. The display will then read the current powerbit value.
53. In this test **SPEED** keys control the power bit setting instead of the actual speed.
54. The **SELECT** key will toggle between a **MPH**, **POWERBITS** and **TIME** display. **TIME** indicates the test's elapsed time. This test is valuable in diagnosing treadmill response to load conditions. As load is increased, the power bits are kept at a constant value (as set via the **SPEED** keys) and the current and belt speed will vary proportionately to the load.
55. It is suggested that you perform this test on a treadmill known to be in excellent operating condition. Note the values displayed at a fixed power bit reading (as set by the **SPEED** keys) and your body weight. Those values may then be used to benchmark the operation of treadmills you are diagnosing.
56. The belt power test is the last test in the diagnostics routine. Press the **RESET** key to exit the diagnostics routine.

Procedure 2.2 - Accessing the Information Display Program

The information display will access the following data;

- Odometer
- Hour meter
- Software version
- Error log

Procedure

1. Plug the power cord into the wall outlet, then turn on the treadmill with the circuit breaker.
2. Press the keys **RESET,6,5**, sequentially.
3. If you are testing a 9.33 or 9.35 treadmill continue with step 4. If you are testing a 9.31 treadmill skip to step 19.

4. The display will momentarily read, **DIAGS - INFORMATION DISPLAY.**

5. The display will momentarily read, **ODOMETER.**

6. The treadmill's odometer will be displayed as **1234567 MPH** or **1234567 KPH.**

Note: The odometer data is stored in non-volatile memory on the upper PCA. If the upper PCA is replaced the odometer data will be lost.

7. Press the **ENTER** key to proceed to the hour meter display.'

8. The display will momentarily read, **HOURLY METER.**

9. The operating time of the unit will be displayed as **12345 HOURS.** The operating time is defined as total amount of time that the unit has operated in program modes with the drive motor running. The hour meter is also used to provide the "time stamp" for the error code log.

10. Press the **ENTER** key to proceed to the software version display.

11. The display will momentarily read, **SOFTWARE VERSION.**

12. The software versions of the upper and lower PCA's will be displayed as;
UPPER 1.01 LOWER 1.01.

13. Press the **ENTER** key to proceed to the error log.

14. The error log will store up to 10 error conditions. The errors are logged with the most recent error in position one. When a new error condition occurs, each existing error is pushed down one position in log. If there was an error in position 10 when a new error was logged, the error that was in position 10 will be lost.
15. Each error in the log will show the odometer reading (in miles) and the time (hour meter) when the error occurred. The errors are displayed as;
1 ER20 1234567 MI 12345 HRS.
16. The arrows keys will allow you to scroll through the log. When the first unused position is reached in the log, the message **NO MORE ERRORS** will be displayed.
17. When the **QUICK START** key is held for 2 seconds the message **HOLD TO CLEAR ERRORS** will be displayed. If the **QUICK START** key is held for an additional 2 seconds, the message **CLEARED** will be displayed. When the **QUICK START** key is released the message **NO MORE ERRORS** will be displayed and all error are erased from the log.
18. Press the **RESET** the **ENTER** key to exit the information display.
19. The display will scroll either **MILES: 1234567** or **KILOMETERS 1234567**. The reading will indicate the total distance that has been recorded on the treadmill.
20. Press the **SELECT** or **RESET** key to continue to the hours display.
21. The display will read **HOURS: 1234**. The reading will indicate the total number of hours of use.
22. Press the **SELECT** or **RESET** key to continue to the software version display.
23. The display will continuously toggle between **UPPER SW VER X.XX.** and **LOWER SW VER X.XX.**
24. Press the **SELECT** or **RESET** key to continue to the error log display.
25. The first error log entry will scroll **1:ERR XX at 123456 MILES 12435 HOURS**. If there are no errors in the log, the message **NO ERRORS** will be scrolled.
26. The **▲** key will move through the log to older errors (if any). If there are no more errors, the message **NO MORE ERRORS** will be scrolled.
27. Pressing and holding the **QUICK START** key for 2 seconds will cause the prompt **CLEAR?** to be displayed, holding the **QUICK START** for an additional 2 seconds will clear all existing entries from the error log. The display will confirm that the error log has been cleared by displaying **OK**. The display will revert to the first log entry and show it as a null entry (**1: ---**). If the **QUICK START** key is not held for a minimum of 4 seconds, the error log will not be cleared.
28. Press the **RESET** or **SELECT** key to exit the information display program.

Procedure 2.3 - Accessing the User Parameter Program

This procedure allows you to change the following settings:

- Set Measurement Units
- Enable/Disable Password
- Set User Name

Procedure

1. Plug the power cord into the wall outlet, then turn on the treadmill with the circuit breaker.
2. Press keys **RESET,5,6,7,1** sequentially.
3. If you are testing a 9.33 or 9.35 treadmill continue with step 4. If you are testing a 9.31 treadmill skip to step 17.
4. The display will momentarily read, **DIAGS - SET USER PARAMETERS.**
5. The display will momentarily read **SELECT UNITS**
6. The currently selected measurement unit will then be displayed.
7. Use the **▲,▼** keys to scroll through the available measurement units.
8. Press the **ENTER** key to select the currently displayed measurement unit.
9. The display will momentarily read, **PASSWORD**
10. Use the **▲,▼** keys to select either **PASSWORD ENABLED** or **PASSWORD DISABLED.**
11. Press the **ENTER** key to exit diagnostics (9.33 only) or to continue to set user name (9.35 only).
12. The display will momentarily read, **USER NAME.**
13. Up to four user names may be entered. If user names have not been previously entered the default user names will be **USER1, USER2, USER3** and **USER4.**
14. The **USER1** name will be displayed first. The **ENTER** key will select **USER2**, then **USER3**, then **USER4.**
15. With the user name to be edited displayed, use the **INCLINE ▲, INCLINE ▼**, to select the character position to be edited. Use the **SPEED ▲, SPEED ▼** keys to select the letter to be placed in the selected character position. The user name can be a maximum of five characters.

16. Press the **ENTER** key to select the next user name or to exit the program.
17. The display will read **SELECT UNITS:** and scroll either **US STANDARD** or **METRIC**.
18. Use the **▲,▼** keys to select the desired measurement units.
19. Press the **RESET** or **SELECT** key to continue with password section.
20. The display will scroll **PASSWORD: ENABLED** or **PASSWORD: DISABLED**. Use the **▲,▼** keys to select the desired setting.
21. Press the **RESET** key to exit the user parameter program.

Procedure 2.4 - Documenting Software Problems

When a problem is found with the software in the upper or lower PCA, record the information listed below.

When a problem occurs, record the following information:

- Model and serial number
- Software version number

- Program number running when the problem occurred
- A description of:
 - a. What happened or failed to happen.
 - b. The action taken by the user just before the problem occurred.
 - c. Problem-related information (such as how far into the program the problem occurred, the work level being used when the problem occurred, etc.).

- The frequency of occurrence.

Section Three - Checking Treadmill Operation

This section provides you with a quick method of checking treadmill operation. Check treadmill operation at the end of a maintenance procedure and when it is necessary to ensure that the treadmill is operating properly.

Procedure

4. Plug the power cord into the wall outlet, then turn on the treadmill with the circuit breaker.
5. Place the treadmill in Manual Mode. Adjust the speed of the running belt to 2–3 m.p.h. Operate the treadmill for at least 5 minutes.
 - a. Concentrate on the feel of the running belt and the sound of the drive motor and rollers. Be on the alert for unusual noises, smells, or vibrations.
 - b. Log the power bits under loaded and unloaded conditions.
 - c. Observe the LED's on the electronic console. Make sure that each LED lights as the information corresponding to that LED is displayed on the electronic console.
3. If during step 1c, squeaking noises associated with the running deck were heard, check the lubrication of the running deck studs. If necessary, apply silicon grease to all of the running deck studs.
3. Press the **STOP** key. When the treadmill comes to a stop, view the electronic console as the treadmill scans time, speed, distance and percent of lift.
4. Press the **INCLINE ▲** key while viewing the electronic console. Confirm that the running bed inclines and the incline display increments to 15% as the **INCLINE ▲** key is pressed.
5. Press the **INCLINE ▼** key while viewing the electronic console. Confirm that the running bed returns to a level position and the incline display decrements to 0% as the **INCLINE ▼** key is pressed.
6. Turn off the treadmill with the circuit breaker, then unplug the treadmill from the wall outlet.

Procedure 4.1 - Calibrating the Lift Motor

1. Set the treadmill circuit breaker in the "off" position and unplug the line cord from the wall outlet.
2. Remove the hood.
3. Place the treadmill on it's right side. Remove hitch and clevis pins that secure the lift tube to the lift platform.

Diagram 4.1 - Lift Motor Mounting

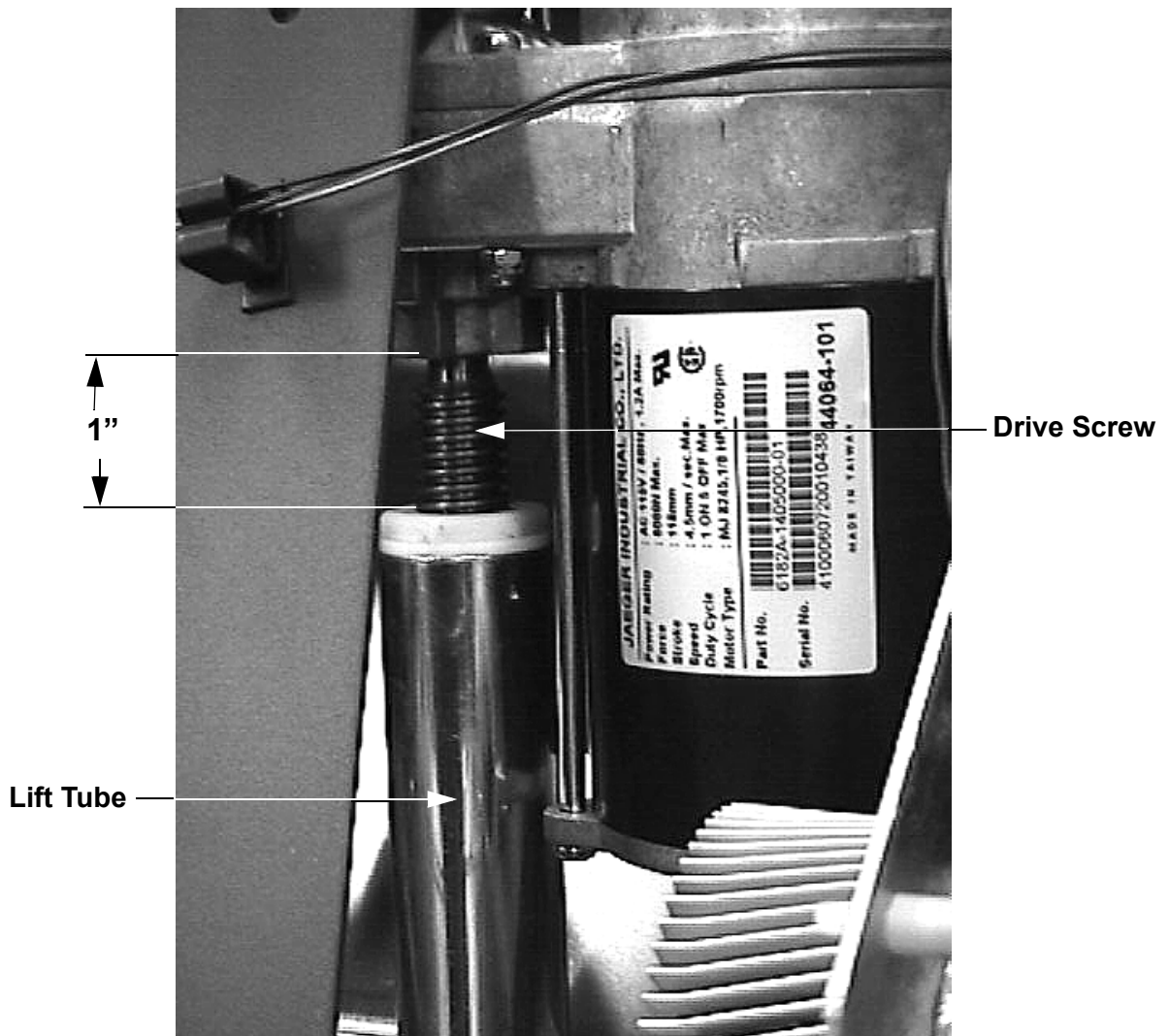

4. Plug the power cord into the wall outlet, set the treadmill circuit breaker in the “on” position.
5. Press keys **RESET, 5,1,7,6,5,7,6,1**, sequentially to enter the diagnostics routine. Refer to Procedure 2.1 and advance to the lift test. When the lift calibration number is displayed on the console, use the **INCLINE ▲** or **INCLINE ▼** key to set the lift calibration number to 20.

CAUTION

While running the lift motor in the diagnostics mode it is possible to operate the lift motor beyond its normal range of motion. When you perform the next step, care must be taken not to jam the lift tube against the motor frame.

6. Press the **RESET** key to exit the diagnostics mode.
7. Set the treadmill circuit breaker in the “off” position, unplug the line cord from the wall outlet.
8. Rotate the lift tube clockwise, by hand, as far as possible. Then rotate the lift tube counter-clockwise until the distance from the top of the lift tube to the lift motor is 1 inch. See Diagram 4.1. While rotating the lift tube, be sure the lift motor drive screw does not rotate. If the drive screw is rotated, return to step 4 and repeat steps 4 through 7.
9. Replace the clevis and hitch pins removed in step 3. Return the treadmill to an upright position.
10. Plug the line cord into the wall outlet, set the treadmill circuit breaker in the “on” position.
11. check the calibration of the lift system by performing the following steps:
 - a Press the **INCLINE ▲** key until the console displays 15% incline.
 - b Press the **INCLINE ▼** key to return to 0% incline.
12. Re-install the hood per Procedure 6.11.

Procedure 4.2 - Adjusting Drive Belt Tension

1. Set the treadmill circuit breaker in the “off” position and unplug the line cord from the wall outlet.
2. Remove the hood.
3. Place the drive belt tension gauge on the drive belt as shown in Diagram 4.2.

Diagram 4.2 - Drive Belt Tension Gauge



4. The gauge should read approximately 80 inch/pounds. The drive belt tension is acceptable if it is in the range of 70 to 90 inch-pounds.
5. If the drive belt tension is less than 70 or greater than 90 inch/pounds, slightly loosen the four drive motor mounting bolts. The drive motor mounts on slotted holes allowing the drive motor to be move forward or rearward. Move the drive motor forward or rearwards, as required, until the belt gauge reads approximately 80 inch/pounds and tighten the four drive motor mounting bolts. See Diagram 4.3. Momentarily remove the drive belt tension gauge from the drive belt. Replace the drive belt tension gauge on the drive belt and re-adjust the drive belt tension, if necessary. Torque the four drive motor mounting bolts to 180 inch pounds.

6. Re-install the hood per Procedure 6.11.

Diagram 4.3 - Drive Belt Adjustment

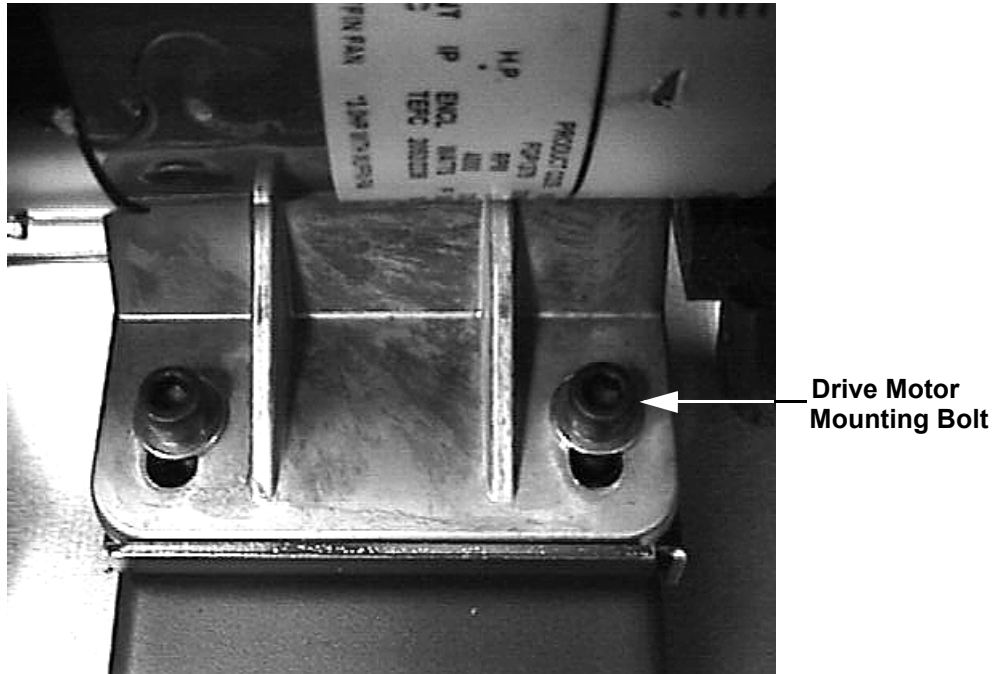

7. Plug the line cord into the wall outlet and set the treadmill circuit breaker in the “on” position.
8. Check treadmill operation per Section 3.

Procedure 5.1 - Troubleshooting the Keypad and Upper PCA

If the function keys on the electronic console are unresponsive, the problem may be either the upper PCA or keypad. The keys on this unit are touch sensitive keys. It is necessary to use the keypad diagnostics to troubleshoot the key functions.

Procedure

1. Set the circuit breaker in the “off” position.

WARNING

Before continuing with this procedure, review the Warning and Caution statements listed in Section One of the Commercial Treadmill Service Manual.

2. If the treadmill powers up and functions normally until a particular key(s) is pressed, skip to step 13.
3. If an Error 5 “key depressed” message is immediately displayed when the treadmill is powered up, continue with the next step.
4. This condition may be caused by either the keypad or upper PCA. Set the circuit breaker in the “off” position. Reach under the display console and disconnect the interconnect cable. See Diagram 5.1.

Diagram 5.1 - Display Console (Bottom View)

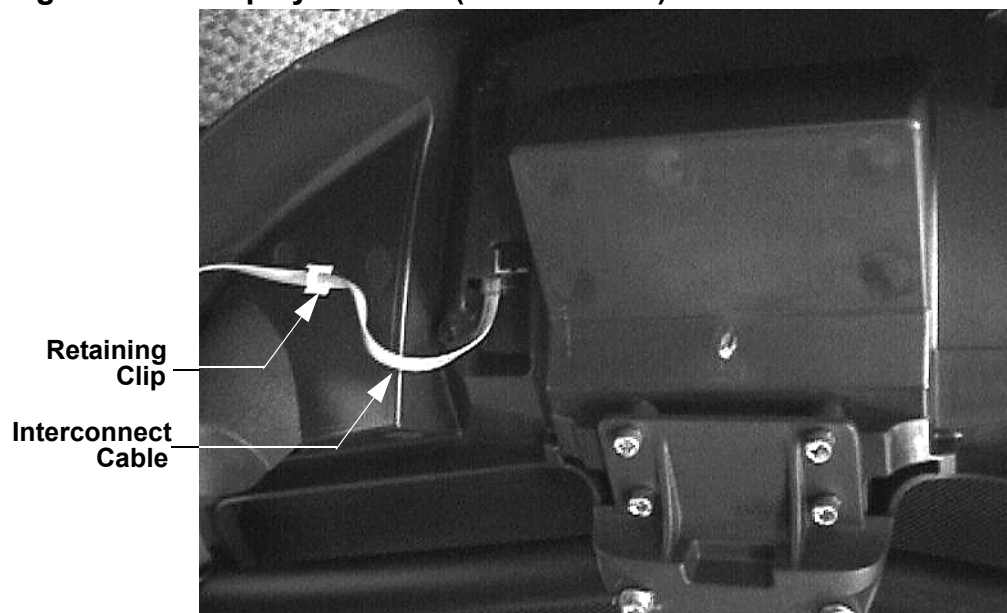

5. Remove the four screws that fastens the display housing front panel to the display housing backing plate. These screws are located on the rear of the display console.

6. Carefully, lift the display housing front panel off of the display housing backing plate. Disconnect the heart rate cable and stop switch cable from the upper PCA.
7. Disconnect the keypad connector from the upper PCA. See Diagram 5.2.

Diagram 5.2 - 9.35 Upper PCA & Keypad

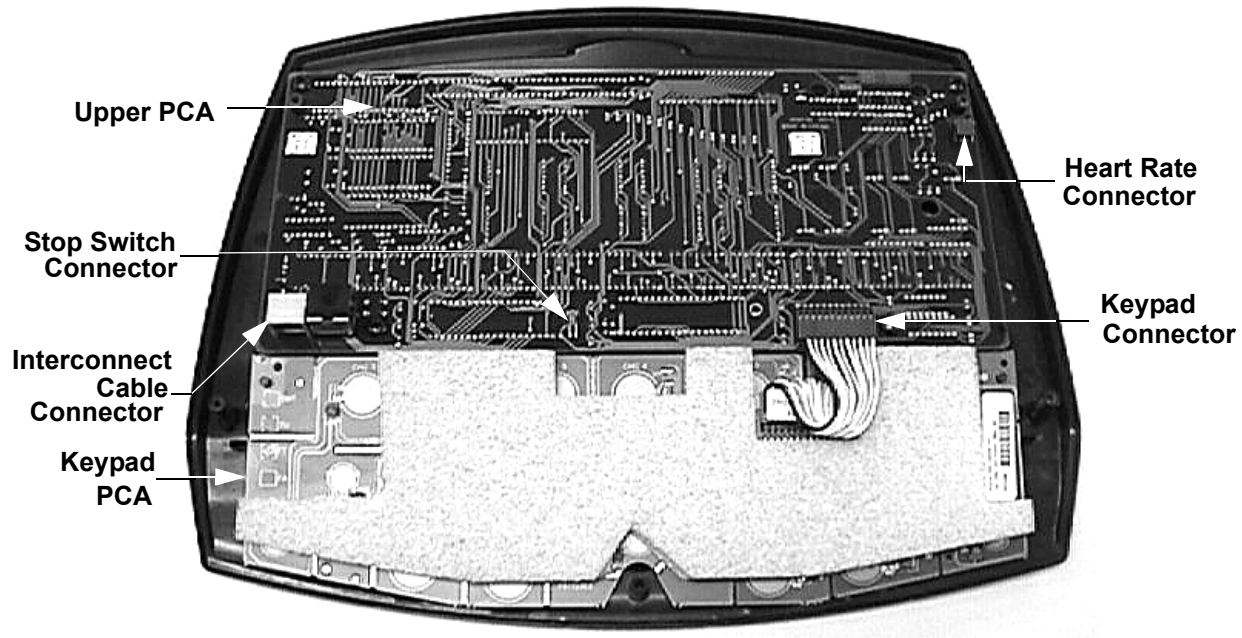

8. Remove the interconnect cable from its retaining clip, See Diagram 5.1. Holding the display housing by the plastic portions, do not handle the upper PCA or keypad PCA, reconnect the interconnect cable to the upper PCA.
9. Set the circuit breaker in the “on” position.
10. If a “key depressed” message is immediately displayed when the treadmill is powered up, replace the upper PCA.
11. If a “key depressed” message is not displayed when the treadmill is powered up, replace the display housing front panel. The display housing front panel is equipped with the keypad.
12. If you have performed all of the procedures above and have been unable to correct the problem, call Precor customer service.
13. Access the diagnostics program per procedure 2.1. If the key(s) necessary to access the diagnostic program is not functioning, skip to step 14.
14. Test the keypad per Procedure 2.1, step 6.
15. If all of the keys test good, the problem may be user error or a key function that is normally disabled during a particular user program.

16. If one or more keys do not function correctly, either the keypad (display housing) or upper PCA could be defective. Replace the display and repeat step 14. If the display housing did not correct the problem, re-install the original display housing and replace the upper PCA.
17. If you have performed all of the procedures above and have been unable to correct the problem, call Precor customer service.

Procedure 5.2 - Troubleshooting the Lift System

Lift System Description:

The lift system on these units consists of an AC line voltage driven lift motor (120 Vac), and an internal 1 K Ω potentiometer for lift position identification. The lift motor contains two motor windings, one to operate the motor in an “upward” direction and the other to operate the motor in a “downward” direction. As the lift motor is operated, the motor also rotates the potentiometer via an internal gear system. Therefore, the position of the lift system can be determined by monitoring the value of the internal potentiometer. The lift motor is initially set at a known starting position (calibration, See Procedure 4.1), subsequent motor movement is tracked via the potentiometer resistance reading.

Note:

All resistance measurements must be performed with power removed from the treadmill. Performing resistance measurements with voltage applied may damage your ohmmeter.

Procedure

1. If the lift motor operates but creates a lift error (error 40 or 42) go to step 16. If the lift motor will not move continue with step 2.
2. Set the treadmill’s circuit breaker in the “off” position and remove the AC line cord from the AC outlet.
3. Remove the F2 (Lift AC) fuse from the lower PCA. Using an ohmmeter, check the resistance of the F2 fuse. See Diagram 5.2. The fuse should measure approximately 0.1 Ω or less. If the fuse is open or high resistance, replace the fuse.

Diagram 5.2 - Lower PCA

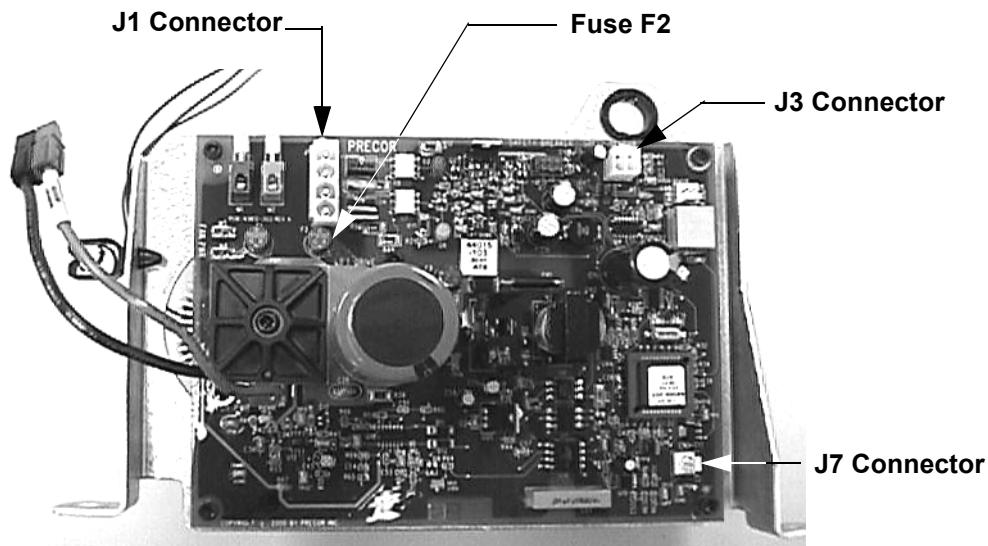

4. Insert the treadmill's line in the AC outlet and set the circuit breaker in the "on" position. Set the treadmill in the manual program and press the **LIFT ▲** key. If the lift motor operates normally, test treadmill operation per Section 3. If the lift motor still does not operate, retest the lift fuse per steps 2 & 3. If the fuse is open again, continue with step 13. If the fuse is good continue with step 5.
5. Connect an AC voltmeter between terminals 1 & 4 of the J1 connector. See Diagram 5.2. Set the treadmill in the manual program and press the **LIFT ▲** key. The AC voltmeter should read AC line voltage (120 Vac) and the red **UP** LED should illuminate. Note that the AC line voltage reading will only be present before an error condition is displayed.
6. If the F2 fuse is good and the **UP** LED illuminates and the AC voltmeter does not read the presence of AC line voltage replace the lower logic PCA per Procedure 6.3.
7. If the **UP** LED does not illuminate and the display indicates that the lift should be moving upward, replace the upper PCA per Procedure 6.8.
8. If the AC voltmeter reads the presence of AC line voltage and an error 40 is displayed, go to step 10.
9. If the AC voltmeter reads the presence of AC line voltage and an error 42 is displayed, continue with step 11.
10. Set the treadmill's circuit breaker in the "off" position and remove the AC line cord from the AC outlet. Remove the lift motor connector from the J1 connector on the lower PCA. Visually inspect the lift motor connector for broken or improperly crimped connections. Using an ohmmeter, read the resistance between terminals 1 & 4 and between terminals 3 & 4. Both readings should be approximately 12 Ω . If either reading is open or very high resistance, replace the lift motor per Procedure 6.1.
11. Set the treadmill's circuit breaker in the "off" position and remove the AC line cord from the AC outlet. Remove the lift motor connector from the J7 connector on the lower PCA. Visually inspect the lift motor connector for broken or improperly crimped connections. Using an ohmmeter, measure between terminals 1 & 3, 1 & 2 and 2 & 3 of the lift motor connector. Terminals 1 and 3 should read approximately 1 K Ω . The sum of the two readings between terminals 2 & 3 and 1 & 2 should total approximately 1 K Ω . If either reading is open or very high resistance, replace the lift motor per Procedure 6.1.
12. If you have performed all of the procedures above and have been unable to correct the problem, call Precor customer service.
13. Set the treadmill's circuit breaker in the "off" position and remove the AC line cord from the AC outlet. Remove the lift motor connector from the J1 connector on the lower PCA. Visually inspect the lift motor connector for broken, frayed or improperly crimped connections. Using an ohmmeter, read the resistance between terminals 1 & 4, 3 & 4 and 1 & 3. The readings should be approximately 12 Ω , 12 Ω and 24 Ω , respectively. If the reading is significantly low, replace the lift motor per Procedure 6.1.

14. If the resistance readings in step 13 are normal, replace the lower logic PCA per Procedure 6.3.
15. If you have performed all of the procedures above and have been unable to correct the problem, call Precor customer service.
16. Set the treadmill's circuit breaker in the "off" position and remove the AC line cord from the AC outlet. Remove the lift motor connector from the J7 connector on the lower logic PCA. Visually inspect the lift motor connector for broken or improperly crimped connections. Using an ohmmeter, measure between terminals 1 & 3, 1 & 2 and 2 & 3 of the lift motor connector. Terminals 1 and 3 should read approximately 1 K Ω . The sum of the two readings between terminals 2 & 3 and 1 & 2 should total approximately 1 K Ω . If either reading is open or very high resistance, replace the lift motor per Procedure 6.1.
17. If the resistance measurements in step 16 are normal, the problem may be either the lower logic PCA or the upper PCA. Replace the lower logic PCA. If the problem persists, reinstall the original lower logic PCA and replace the upper PCA.
18. If you have performed all of the procedures above and have been unable to correct the problem, call Precor customer service.

Procedure 5.3 - Troubleshooting the Speed Sensor

Note:

The speed sensor is a hall effect sensor that emits a pulse when a flywheel lobe passes between its transmitter and receiver. The speed control circuit processes the pulse train emitted by the speed sensor. The speed sensor signal is a real time representation of the operating speed of the treadmill. The speed control circuit compares the real time speed (speed sensor output) with the speed that it expects the treadmill to be operating at and acts accordingly to control treadmill speed or initiate an error code sequence, if necessary. Typically, if a problem exists with the speed sensor the drive motor will operate (perhaps only briefly) before a speed related error occurs (errors 20-26).

1. Set the treadmill circuit breaker in the "on" position. Using a DC voltmeter, measure the voltage between terminal 3 of J3 (green wire) and terminal 4 of J3 (black wire) on the lower PCA. Slowly, rotate the drive motor flywheel. The voltage should read approximately 0.25 Vdc when a flywheel lobe is between the speed sensor "legs" and approximately 5 Vdc when a flywheel lobe is not between the speed sensor "legs".

Diagram 5.3 - Speed Sensor Mounting

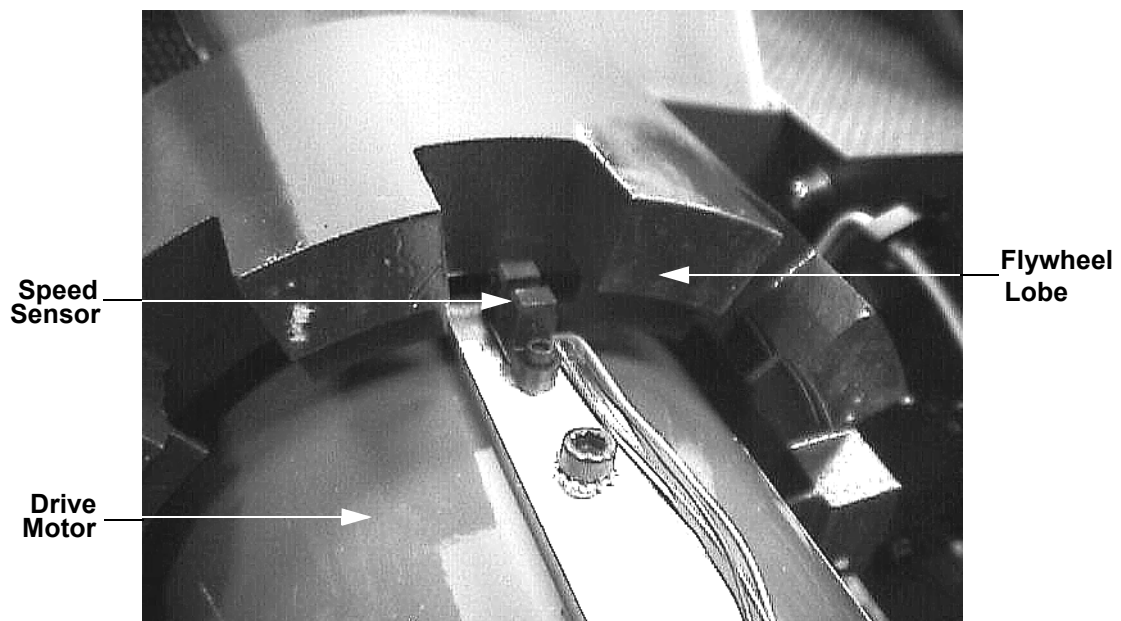

2. If the voltages in step 1 are correct, go to step 5. If the voltage in step 1 is 0 Vdc or significantly low when a flywheel lobe is between the speed sensor "legs", continue with step 3.

3. Measure the voltage between terminal 1 of J3. (red wire) and terminal 4 of J3 (black wire) on the lower PCA, see Diagram 5.2. The voltage should read approximately 5 Vdc. If the voltage is missing or significantly low, disconnect the speed sensor plug from the lower PCA. Measure the voltage between pins 1 & 4 of the J3 connector on the lower PCA. If the voltage is approximately 5 Vdc, replace the speed sensor. If the voltage is missing or significantly low, replace the lower logic PCA.
4. If at this point the speed sensor output is good, but a speed error occurs, replace the upper PCA.
5. If you have performed all of the above procedures and have been unable to correct the problem, call Precor Customer Support.

Procedure 5.4 - Troubleshooting the External A.C. Power Source

It is extremely important that any Precor treadmill be connected to and operated on a dedicated 20 amp A.C. circuit. A 20 amp dedicated circuit is defined as: a circuit fed by a 20 amp circuit breaker that feeds a single load. A treadmill operating from a non-dedicated circuit or a circuit breaker of less than 20 amps capacity will not have the necessary power available to operate normally under higher load conditions. The lack of available power can cause any number of symptoms ranging from numerous intermittent (seemingly inexplicable) error conditions, poor speed control, or tripping the house circuit breaker.

If any of the above symptoms exist the external A.C. circuit must be checked and confirmed to be a 20 amp dedicated circuit **before** troubleshooting the treadmill.

In addition the A.C. voltage must be checked. Nominal A.C. operating voltage on 120 Vac circuits is 105 Vac to 120 Vac. Nominal A.C. operating voltage on 240 Vac circuits is 208 Vac to 240 Vac.

For operator safety considerations and to minimize electrostatic discharge conditions the A.C. frame ground continuity must also be verified to be a low resistance connection to the A.C. distribution ground bar.

Important

If the A.C. circuit feeding a treadmill is found to be a non-dedicated circuit or a circuit equipped with a circuit breaker with a capacity of less than 20 amps, the A.C. circuit must be corrected to be a 20 amp dedicated circuit **before** any reliable troubleshooting can be performed on the treadmill. More importantly, a non-dedicated circuit may constitute a safety hazard to the treadmill operator.

120 Vac Systems

120 Vac distribution systems utilize a single pole circuit breaker (hot lead) and a neutral lead connected to a common neutral (ground) bar. The A.C. safety ground (green wire) is connected to a separate ground bar in the distribution system.

The most common problems found are (1) the circuit is fed by a circuit breaker of less than 20 amp capacity, (2) the circuit breaker correctly feeds a single A.C. outlet but the neutral is common between several A.C. outlets and (3) both the hot and neutral leads feed several A.C. outlets. The appropriate correction action or actions (see below) must be followed if any of the above conditions exist. **Corrective actions should only be undertaken by a licensed electrician.**

1. The circuit breaker feeding the treadmill is not a 20 amp circuit breaker.

If the circuit breaker is greater than 20 amps, the circuit breaker should be replaced with a 20 amp circuit breaker. If the circuit breaker is less than 20 amps the circuit breaker must be replaced with a 20 amp circuit breaker and the wiring from the A.C. distribution must be capable of safely handling 20 amps. If the A.C. wiring is under sized, it must be replaced with wire capable of safely handling 20 amps. Please, refer to local electrical codes when determining the appropriate wire size for a 20 amp circuit.

2. The circuit breaker correctly feeds a single A.C. outlet but the neutral is common between several A.C. outlets.

The common neutral lead must be removed from treadmill's A.C. outlet and a new neutral lead from the treadmill's A.C. outlet to the A.C. neutral distribution bar must be added.

3. Both the hot and neutral leads feed several A.C. outlets.

Both the common neutral and hot leads must be removed from treadmill's A.C. outlet and a new neutral lead and hot lead from the treadmill's A.C. outlet to the A.C. neutral distribution bar and circuit breaker must be added.

240 Vac Systems

240 Vac distribution systems utilize a double pole circuit breaker (two hot leads) The A.C. safety ground (green wire) is connected to a ground bar in the distribution system.

The most common problems found are (1) the circuit is fed by a circuit breaker of less than 20 amp capacity and (2) both the hot leads feed several A.C. outlets. The appropriate correction action or actions (see below) must be followed if any of the above conditions exist. **Corrective actions should only be undertaken by a licensed electrician.**

1. The circuit breaker feeding the treadmill is not a 20 amp circuit breaker.

If the circuit breaker is greater than 20 amps, the circuit breaker should be replaced with a 20 amp circuit breaker. If the circuit breaker is less than 20 amps the circuit breaker must be replaced with a 20 amp circuit breaker and the wiring from the A.C. distribution must be capable of safely handling 20 amps. If the A.C. wiring is under sized, it must be replaced with wire capable of safely handling 20 amps. Please, refer to local electrical codes when determining the appropriate wire size for a 20 amp circuit.

2. Both the hot leads feed several A.C. outlets.

Both hot leads must be removed from treadmill's A.C. outlet and two new hot leads from the treadmill's A.C. outlet to the circuit breaker must be added.

A licensed electrician may use the followings hints to determine if an A.C. service is dedicated.

1. If, on a 120 Vac system, the A.C. distribution panel contains more circuit breakers than neutral leads, the system has shared neutral leads and is not dedicated.
2. If an A.C. outlet (120 or 240 Vac) has multiple hot and/or neutral leads, it is not a dedicated.
3. If either of the above conditions exist, the system is not dedicated. However, absence of the above conditions does not necessarily mean that the system is dedicated. If any doubt exists about A.C. systems dedication, point to point tracing of the A.C. wiring may be the only way to prove system dedication.

Procedure 6.1 - Replacing the Lift Motor

Note:

The replacement lift motor must be calibrated prior to installation. The defective lift motor is then removed and the calibrated replacement lift motor is installed.

1. If the incline is at 0%, skip to step 3.
2. Set the treadmill circuit breaker in the “on” position. Press the **QUICK START** to start the running belt. Use the **INCLINE ▼** key to lower the incline to 0%
3. Set the treadmill circuit breaker in the “off” position and remove the AC line cord from the AC outlet.
4. Disconnect the lift motor plugs from J1 and J7 connectors of the lower logic PCA. See Diagram 5.2. Remove the lift motor’s green frame ground wire from the lift motor support bracket.
5. Lay the replacement lift motor on the floor in front of the treadmill and connect it’s two plugs to the J1 & J7 connectors of the lower logic PCA.
6. Calibrate the lift motor per Procedure 4.1, steps 4-7.
7. Lay the treadmill on either its left or right side as convenient.
8. Remove the hitch and clevis pins from the top and bottom of the lift motor. Remove the lift motor from the treadmill.
9. Set the calibrated lift motor in its mounting position. Replace the upper clevis and hitch pins.
10. Replace the lower clevis and hitch pins. It may be necessary to slightly rotate the lift tube to align it so that the clevis pin may be inserted. To align the hole in the lift tube rotate it in the direction that will cause the least amount of rotation to make alignment possible.
11. Route the lift motor cables to the lower PCA. Plug the lift motor plugs into the J1 & J7 connectors on the lower logic PCA.
12. Check treadmill operation per Procedure 3.

Procedure 6.2 - Replacing the Lift Platform

1. Set the treadmill circuit breaker in the “off” position. Remove the AC line cord from the AC outlet.
2. Remove the treadmill hood. Carefully, lay the treadmill on it's right side.
3. Remove the hitch pin and clevis pin that fastens the lift motor tube to the lift platform. While the lift tube is not fastened to the lift platform, care must be taken to not allow the lift tube to rotate. If the lift tube rotates, the lift motor must be re-calibrated per Procedure 4.1.
4. Using a punch or stout screwdriver press the lift platform mounting pins toward the treadmill frame and out of the lift platform. Remove the lift platform from the treadmill.

Diagram 6.1 - Lift Platform Mounting Pin

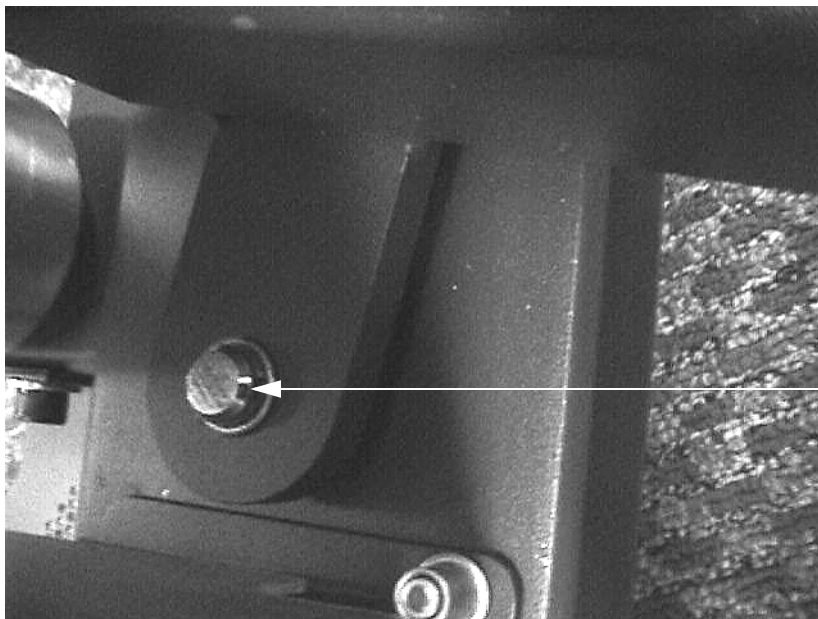

**Lift Platform
Mounting Pin**

5. With a screwdriver or similar tool carefully pry the forward end of the aluminum treadmill frame trim away from the treadmill frame, see Diagram 6.2.
6. Using a flat bladed tool, reach under the treadmill trim and press the lift platform mounting pin into the lift platform. Replace the hitch pin in the lift platform mounting pin. Press the treadmill frame trim back into place.
7. Hold the lift platform against the bottom of the treadmill and carefully roll the treadmill back into an upright position. Carefully lay the treadmill on its left side and repeat the procedure in step 6.

Diagram 6.2 - Treadmill Frame Trim

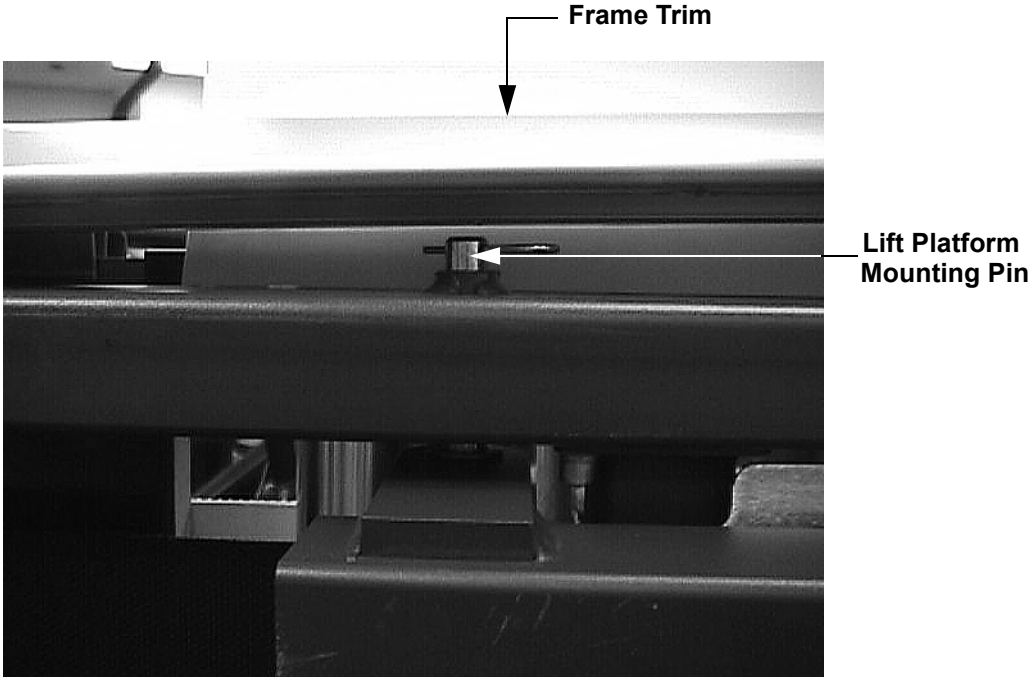

Front →

- 8. Check treadmill operation per Procedure 3.

Procedure 6.3 - Replacing the Lower PCA

1. Set the treadmill circuit breaker in the “off” position. Remove the AC line cord from the AC outlet.
2. Disconnect the lower PCA drive motor connector from the drive motor. Disconnect Both lift motor connectors, the speed sensor connector, the drive motor fan connectors, the lower PCA fan connector and the AC input wires from the lower PCA.
3. Remove both lower PCA mounting screws and remove the lower PCA. See Diagram 6.3.

Diagram 6.3 - Lower PCA

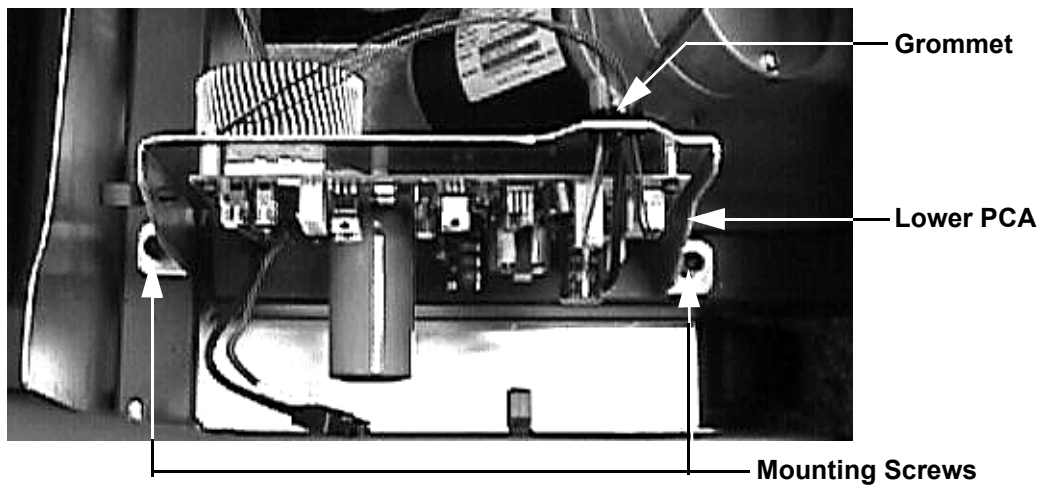

4. Set the replacement lower PCA in its mounting position and fasten it with the screws removed in step 3. Torque the lower PCA mounting screws to 120 inch pounds.
5. The AC input wires are the blue and brown wires AC line filter on the front dress panel. Connect the brown AC input wire to the M2 terminal and the blue AC input wire to the M1 terminal of the lower PCA.
6. Connect the brown drive motor fan wire to terminal M4 and the blue drive motor fan wire to the M5 terminal on the lower PCA.
7. Connect the black and red drive motor wires to the mating black and red connectors on the lower PCA.
8. Feed the speed sensor connector through the grommet in the lower PCA bracket and insert it in the J3 connector of the lower PCA.
9. Feed the lower PCA fan r connector through the grommet in the lower PCA bracket and insert it in the J4 connector of the lower PCA.

10. Feed the three pin lift motor connector through the grommet in the lower PCA bracket and insert it in the J7 connector of the lower PCA.
11. Insert the large lift motor connector in the J1 connector of the lower PCA.
12. Dress all of the above wiring into the appropriate wire clips along their routing.
13. Insert the AC line cord from the AC outlet. Set the treadmill circuit breaker in the "on" position.
14. Check treadmill operation per Procedure 3.

Procedure 6.4 - Replacing the Speed Sensor

1. Set the treadmill circuit breaker in the “off” position. Remove the AC line cord from the AC outlet.
2. Disconnect the plug from the J3 connector on the lower PCA.
3. Rotate the flywheel so that the speed sensor is between flywheel lobes.
4. Remove the screws that fastens the speed sensor mounting bracket to the treadmill drive motor. See Diagram 6.4.

Diagram 6.4 - Speed Sensor Mounting

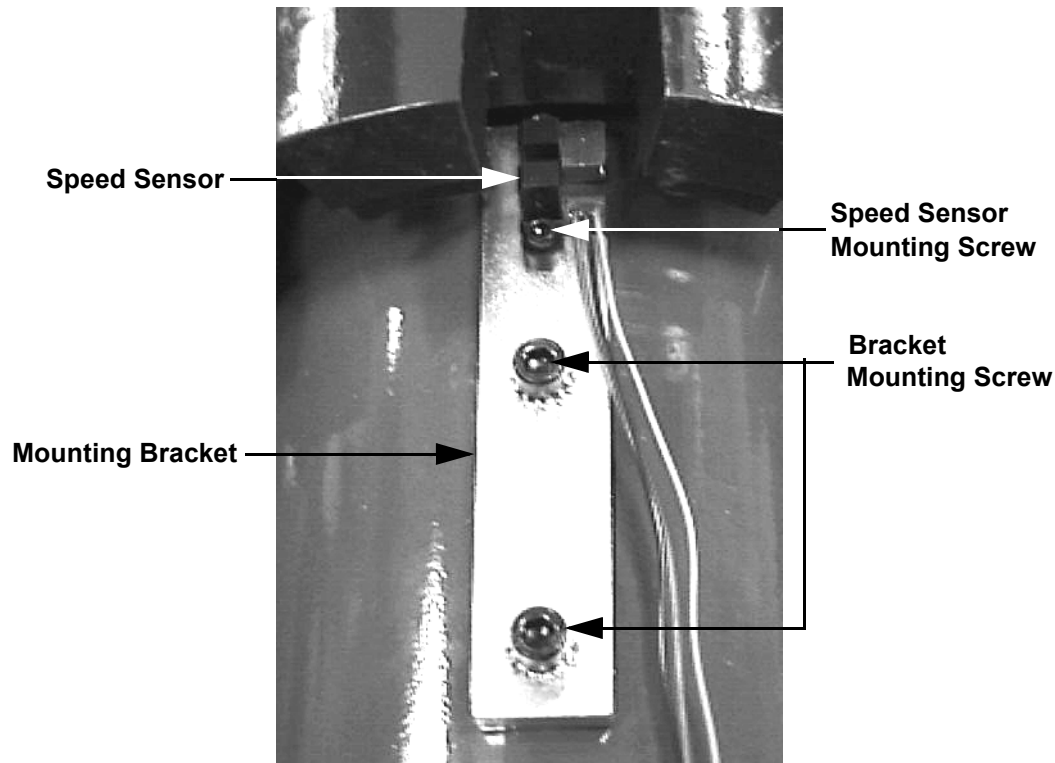

5. Remove the mounting bracket from the drive motor.
6. Remove the two screws that fasten the speed sensor to the bracket.
7. Mount the replacement speed sensor on the mounting bracket with the screws removed in step 6. Torque the screws to 8 inch pounds.
8. Mount the bracket on the drive motor with the screws removed in step 4. Torque the mounting screws to 25 inch pounds.

9. Feed the speed sensor connector through the grommet in the lower PCA bracket and insert it in the J3 connector of the lower PCA.
10. Slowly rotate the flywheel to ensure that the flywheel lobes do not contact the speed sensor.
11. Set the treadmill circuit breaker in the “on” position and check treadmill operation per Procedure 3.

Procedure 6.5 - Replacing Drive Motor

1. Set the treadmill circuit breaker in the “off” position and unplug the treadmill’s line cord from the AC outlet.
1. Remove the hood.
2. The drive motor and flywheel are balanced as a matched pair. Since the flywheel is balanced to a specific motor, flywheels should not be removed from one and installed on a different motor. If the drive motor is replaced, the drive motor and flywheel should be replaced as a unit.
3. Remove the screws that fastens the speed sensor mounting bracket to the treadmill drive motor. See Diagram 6.4. Move the speed sensor and bracket as far from the drive motor as possible.
4. Remove the blue and brown wires from the drive motor cooling fan (9.35 only).
5. Disconnect the red and black drive motor wires from the lower PCA.
6. Loosen the four drive motor mounting bolts. See Diagram 4.3. Remove the drive belt from the drive motor pulley.
7. Remove the four bolts that fasten the drive motor to its mounting base. Remove the drive motor from the treadmill.
8. Remove the four screws that fasten the drive motor cooling fan onto the drive motor. Remove the fan from the drive motor (9.35 only).
9. Mount the drive motor cooling fan onto the replacement drive motor with the screws removed in step 7. Torque the fan mounting screws to 25 inch pounds.
10. Set the drive motor in it’s mounting position. Replace and hand tighten the drive motor mounting screws removed in step 6. Set the drive belt in place on the drive motor pulley.
11. Tension the drive belt and mount the drive motor per Procedure 4.2, steps 3-5.
12. Connect the brown and blue fan wires to the drive motor cooling fan. The blue and brown wires can be connected to either terminal (9.35 only).
13. Connect the black and red drive motor wires to the mating black and red connectors on the lower PCA.
14. Set the speed sensor and mounting bracket in position on the drive motor and fasten with the screws removed in step 3. Torque the mounting screws to 25 inch pounds.
15. Re-install the hood.per Procedure 6.11

16. Check treadmill operation per Procedure 3.

Procedure 6.6- Replacing the Circuit Breaker

1. Set the treadmill circuit breaker in the “off” position and unplug the treadmill’s line cord from the AC outlet.
2. Remove the sheet metal screw that is approximately in the center of the treadmill dress panel. Remove the four bolts that fasten the treadmill dress panel to the treadmill.

Diagram 6.5 - Treadmill Dress Panel (Rear View)

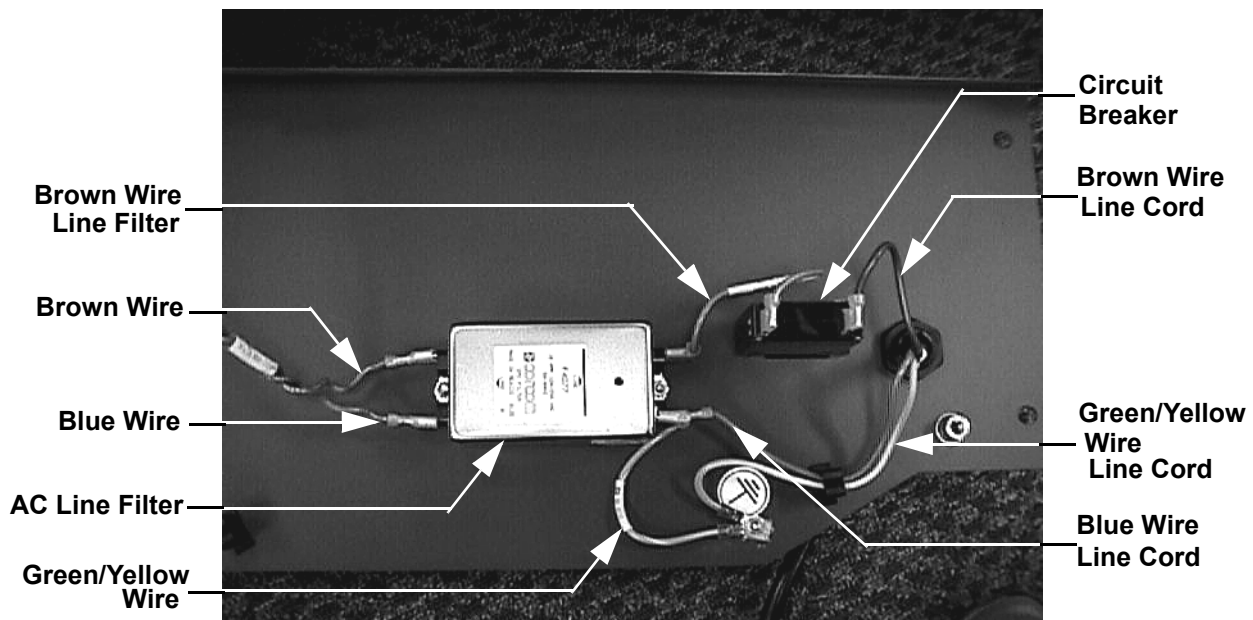

3. Disconnect both brown wires from the circuit breaker.
4. Note the orientation of the circuit breaker in the dress panel. The replacement circuit breaker must be mounted in the same orientation. Remove the circuit breaker mounting screws. Remove the circuit breaker from the treadmill.
5. Set the replacement circuit breaker in its mounting position. When viewed from the front the circuit breaker labeling should be with “OFF” on the right hand side. Fasten the circuit breaker to the treadmill dress panel using the screws removed in step 4.
6. Connect the brown wires from the line cord and AC line filter as shown in Diagram 6.5.
7. Set the dress panel in its mounting position, hand start the four mounting bolts and the sheet metal screw removed in step 2. Torque the four dress panel bolts to 120 inch pounds. Torque the sheet metal screw to 90 inch pounds.
8. Replace the hood per Procedure 6.11.

9. Check treadmill operation per Section 3.

Procedure 6.7 - Replacing the Line Filter

1. Set the treadmill circuit breaker in the “off” position and unplug the treadmill’s line cord from the AC outlet.
2. Remove the sheet metal screw that is approximately in the center of the treadmill dress panel. Remove the four bolts that fasten the treadmill dress panel to the treadmill.
3. Disconnect all of the wiring from the line filter.
4. Remove the mounting hardware that fastens the line filter to the treadmill dress panel.
5. Set the replacement line filter in it’s mounting position, the side with three terminals must face the circuit breaker. Fasten the line filter to the treadmill dress panel with the mounting hardware removed in step 4.
6. Connect the wiring to the line filter per Diagram 6.10.
7. Replace the AC line filter wiring as shown in Diagram 6.5.
8. Set the dress panel in its mounting position, hand start the four mounting bolts and the sheet metal screw removed in step 2. Torque the four dress panel bolts to 120 inch pounds. Torque the sheet metal screw to 90 inch pounds.
9. Replace the hood per Procedure 6.11.
10. Check treadmill operation per Section 3.

Procedure 6.8 - Replacing the Line Cord

1. Set the treadmill circuit breaker in the “off” position and unplug the treadmill’s line cord from the AC outlet.
2. Remove the sheet metal screw that is approximately in the center of the treadmill dress panel. Remove the four bolts that fasten the treadmill dress panel to the treadmill.
3. Remove the nut that fastens the line cord’s ground wire (green/yellow wire) to the dress panel.
4. Disconnect the line cord’s brown wire from the circuit breaker. Disconnect the line cord’s blue wire from the line filter.
5. Remove the line cord’s strain relief mounting nut and remove the line cord.
6. Remove the mounting nut from the replacement line cord and feed the replacement line cord through the treadmill dress panel. Fasten the line cord to the circuit breaker mounting plate with the nut removed in the previous step.
7. Connect the line cord’s brown wire to the circuit breaker per Diagram 6.5.
8. Connect the line cord’s blue wire to the line filter per Diagram 6.5.
9. Connect the line cord’s ground wire (green/yellow wire) to the treadmill dress panel with the hardware removed in step 3.
10. Set the dress panel in its mounting position, hand start the four mounting bolts and the sheet metal screw removed in step 2. Torque the four dress panel bolts to 120 inch pounds. Torque the sheet metal screw to 90 inch pounds.
11. Replace the hood per Procedure 6.11.
12. Check treadmill operation per Section 3.

Procedure 6.9 - Replacing the Drive Motor Cooling Fan (9.35 Only)

1. Set the treadmill circuit breaker in the “off” position and unplug the treadmill’s line cord from the AC outlet.
2. Remove the hood.
3. Remove the brown and blue wires from the drive motor cooling fan.
4. Using a right angle screwdriver, remove the four screws that mount the drive motor cooling fan to the drive motor. See Diagram 6.6

Diagram 6.6 - Drive Motor Cooling Fan Mounting

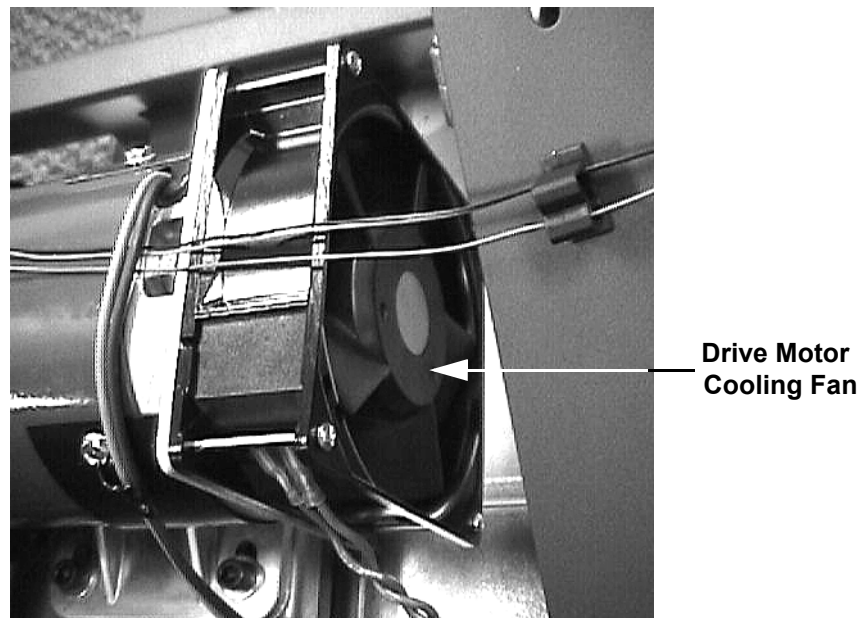

5. Set the replacement drive motor cooling fan at it’s mounting position on the drive motor and fasten it with the hardware removed in step 4. Torque the mounting screws to 25 inch pounds.
6. Replace the drive motor cooling fan wiring removed instep 3. The wires may be connected to either terminal.
7. Replace the hood per Procedure 6.11.
8. Check treadmill operation per Procedure 3.

Procedure 6.10 - Replacing the Drive Motor Brushes

1. Set the treadmill circuit breaker in the "off" position and unplug the treadmill's line cord from the AC outlet.
1. Remove the hood.
2. Remove the screws that retain the drive motor brush cover. Carefully, remove the heavy paper cover from the brush access opening.
3. Disconnect the brush wire from the tab on the brush housing. Remove the brush spring by depressing the tab on the brush spring.
4. Remove the brush from it's brush holder. See Diagram 6.7.

Diagram 6.7 - Drive Motor Brush

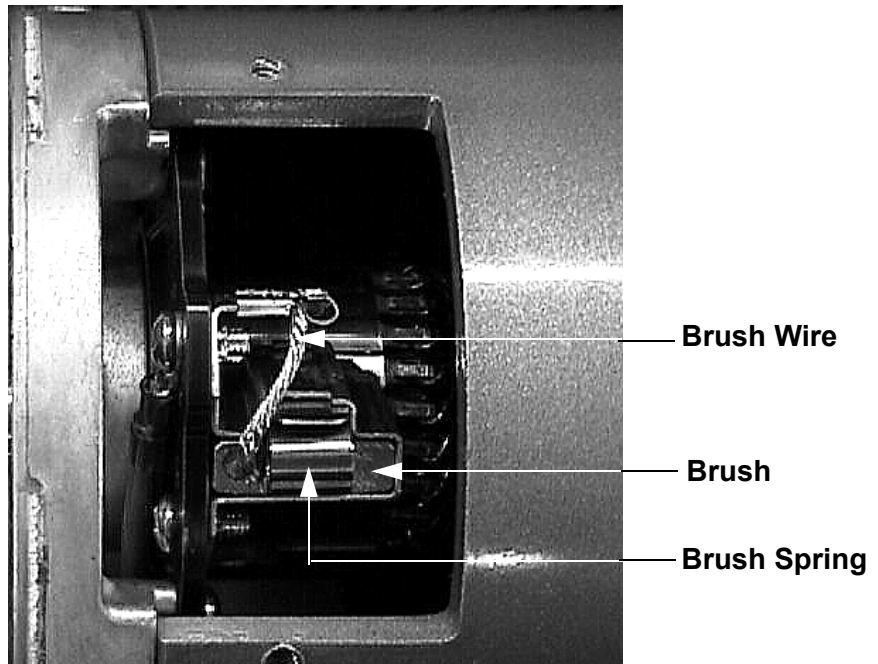

5. Slide the replacement brush into the brush holder. Be sure that the angled edge of the brush is oriented so that the brush face makes full contact with the motor commutator.
6. Reinstall the brush spring and connect the brush wire to the tab on the brush holder.
7. Replace the heavy paper cover in the brush access opening. Replace the brush cover and fasten it with the screws removed in step 3.
8. Repeat 3-8 with remaining drive motor brush.

9. Replace the hood per Procedure 6.11.
10. Check treadmill operation per Procedure 3.

Procedure 6.11 - Removing and Replacing the Hood

1. Set the treadmill circuit breaker in the “off” position and unplug the treadmill’s line cord from the AC outlet.
2. Remove the four bolts that mount the hood the treadmill. Note that only two front bolts utilize flat washers
3. Remove the hood from the treadmill.
4. The rear hood mounting nuts are mounted in slots and are able to “float”

Diagram 6.8 - Rear Hood Mounts

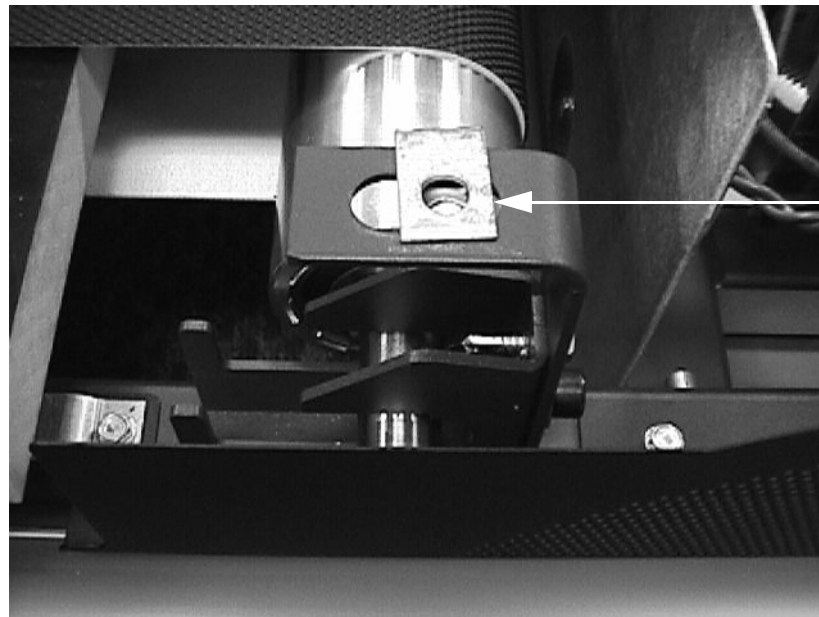

5. Set the replacement hood in its mounting position. Using a thin bladed screwdriver or similar tool into one of the rear hood mounting holes and use the screw driver to align the hood mounting nut with the hole in the hood. Hand start one of the rear hood mounting bolts.
6. Repeat step 5 for remaining rear hood mount.
7. Hand start the two front hood mounting bolts. Torque all four hood mounting bolts to 120 inch pounds.

Procedure 6.12 - Replacing the PROM

Anti-static kits (part number 20024-101) can be ordered from Precor.

1. The PROM and the associated printed circuit assembly (PCA) are static sensitive. Anti-static devices must be used and all anti-static precautions must be followed during this procedure.
2. Remove the printed circuit assembly per its associated procedure.
3. Currently we are using two styles of IC software packages. they are a 28 pin dual in line package (DIP28) and a forty-four pin square package (PLCC44). Each of these packages should be removed with a proper IC removal tool (see the illustrations below)



4. The IC's may inserted into their socket by hand by carefully aligning the notch on the IC with the notch on the IC socket and carefully pressing the IC into its socket. See the illustrations below for the alignment notches. Care must be taken that the IC legs on a DIP28 are all aligned in the socket to prevent the legs from bending when inserted. The PLCC44 IC must be carefully aligned squarely in its socket or it will not insert. Do not force the IC into its, socket. If it does not insert easily, remove the it and re-align it in its socket.

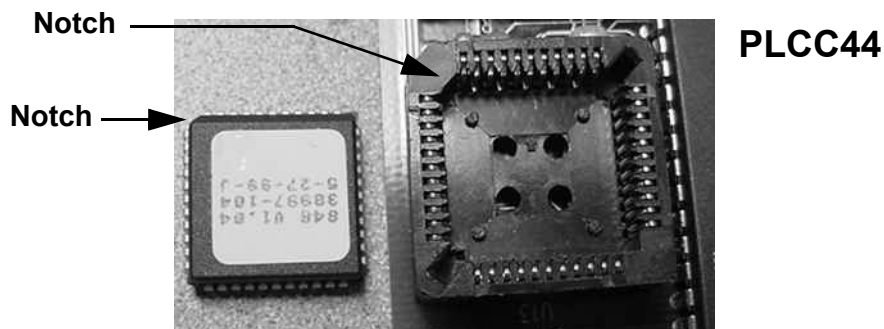
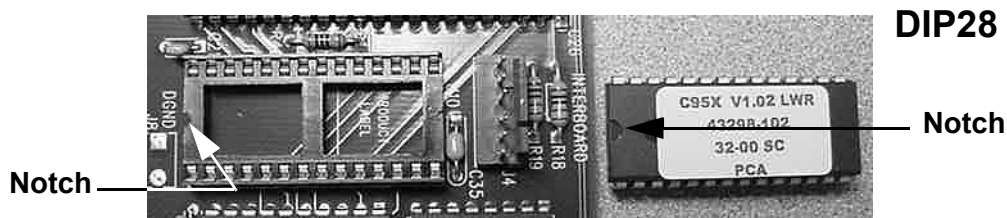

Wiring Diagram 7.1 - 9.31, 9.33, 9.35

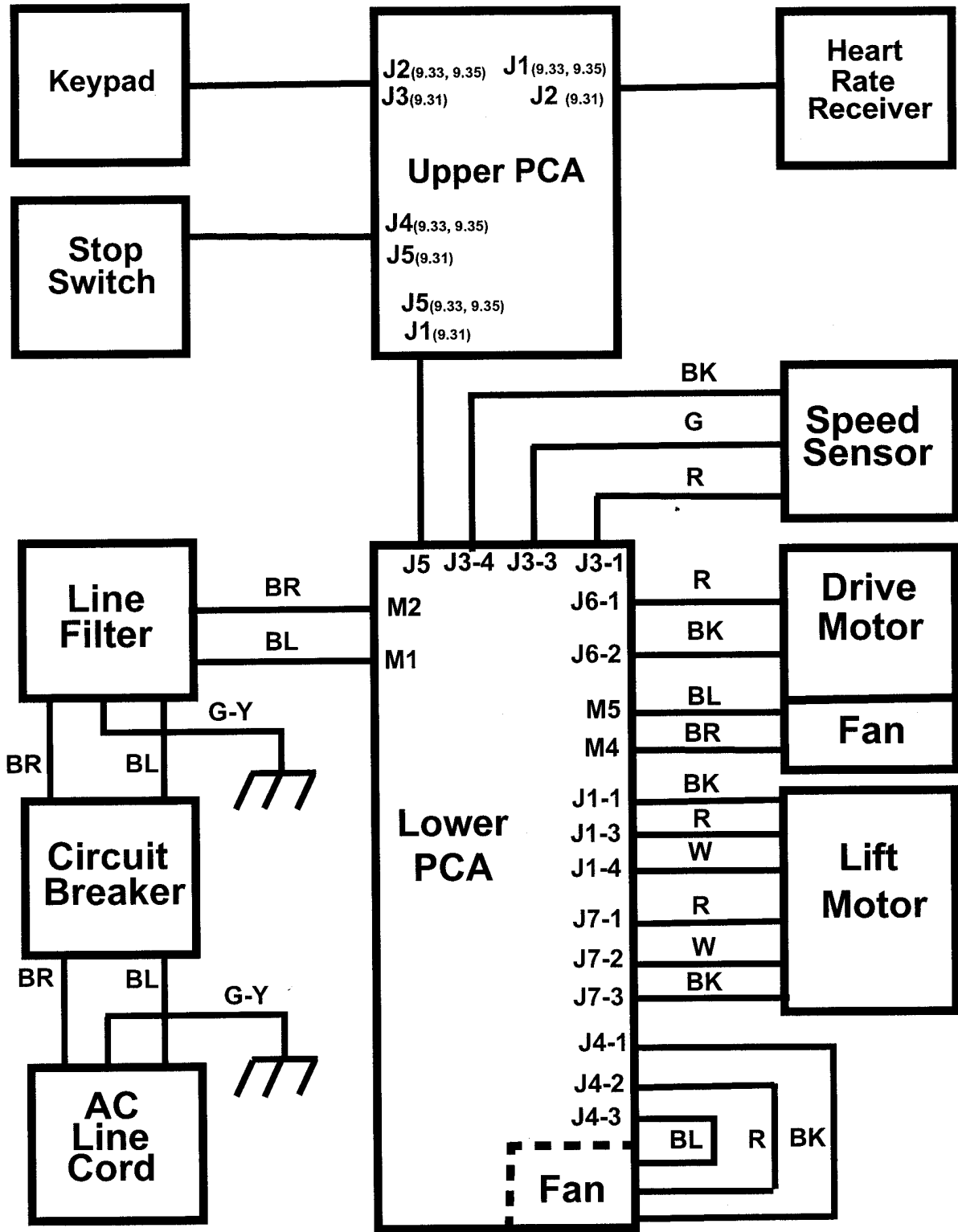

Block Diagram 7.2 - 9.31, 9.33, 9.35



9.31, 9.33, 9.35 PWM Treadmill

LPCA Light Emitting Diodes

Desig	Color	Description
D2	Red	Lift Up
D3	Red	8.5 Vdc
D6	Green	Lift Down

