

EXPLODED DRAWING A

Model No. NTL29012.0 R0513A

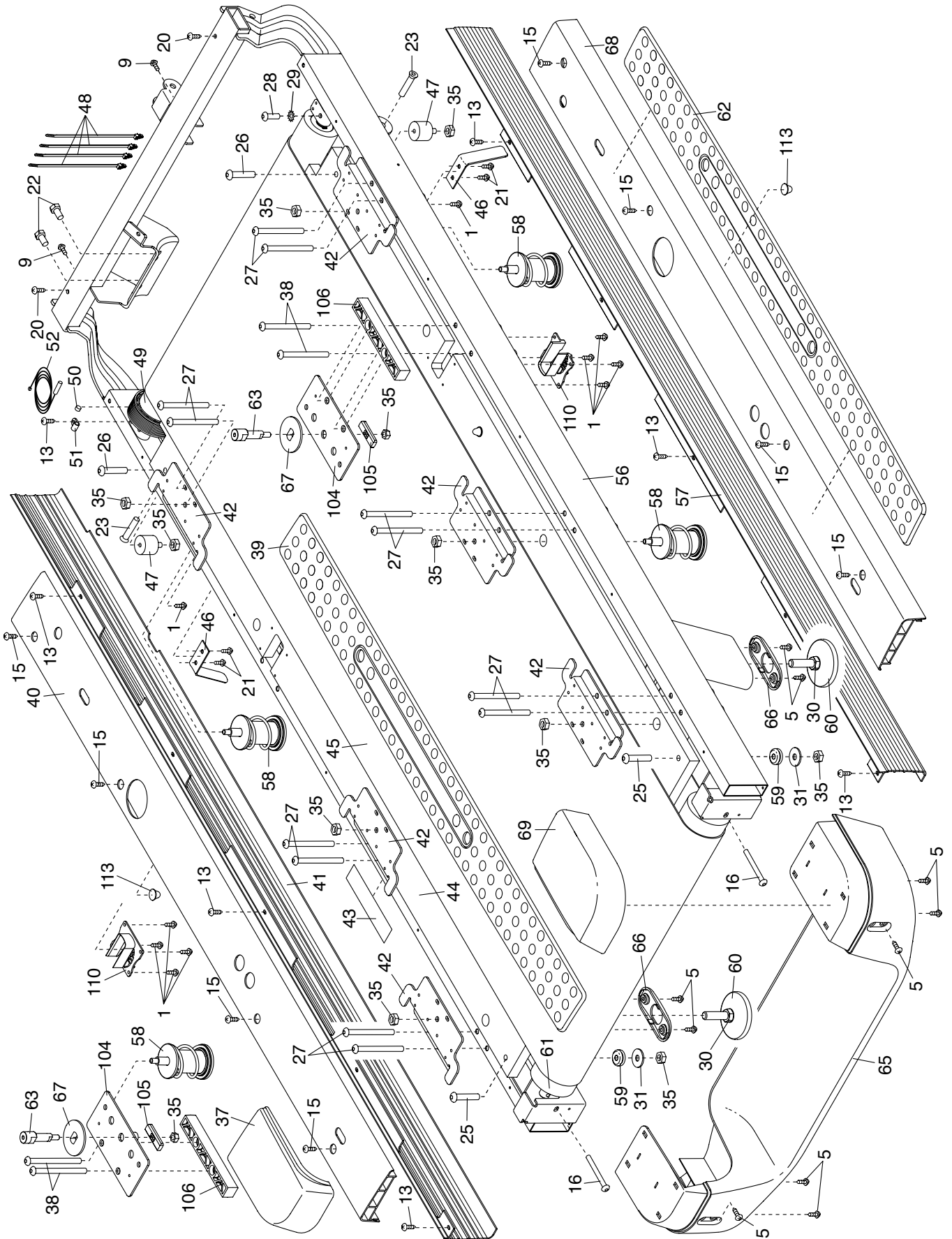

EXPLODED DRAWING B

Model No. NTL29012.0 R0513A

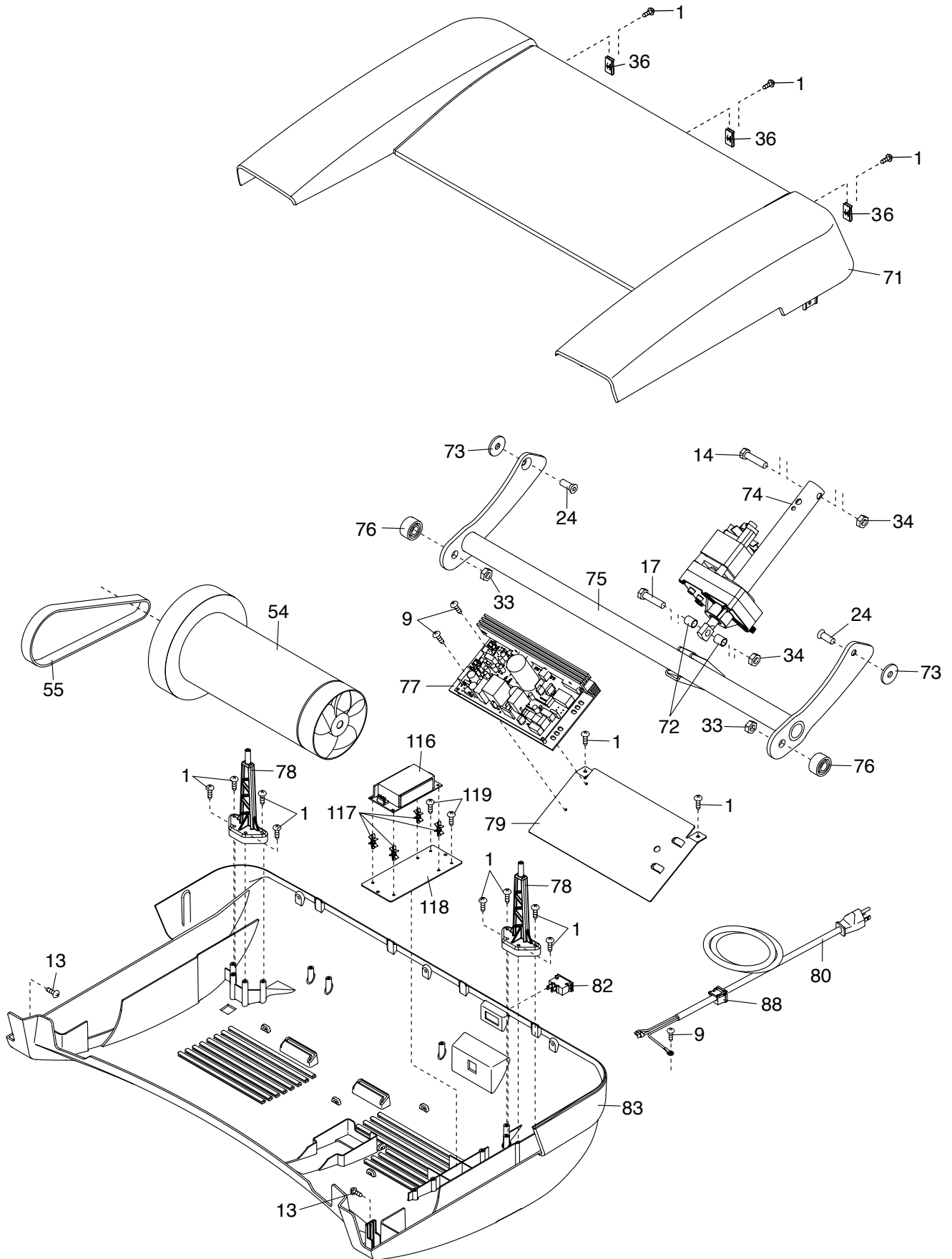

EXPLODED DRAWING C

Model No. NTL29012.0 R0513A

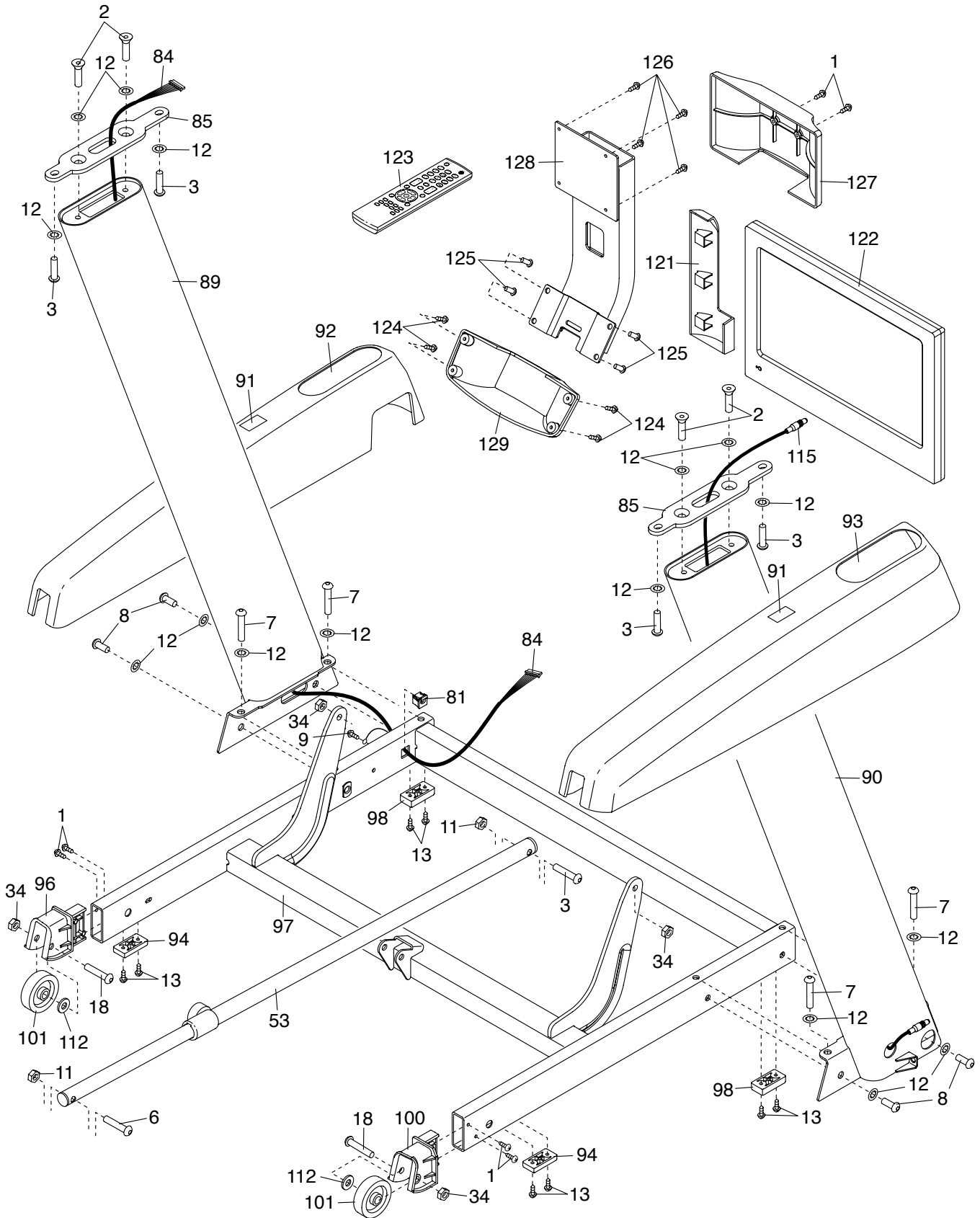

EXPLODED DRAWING D

Model No. NTL29012.0 R0513A

