

EXPLODED DRAWING—Model No. PFTL71330

R0803A

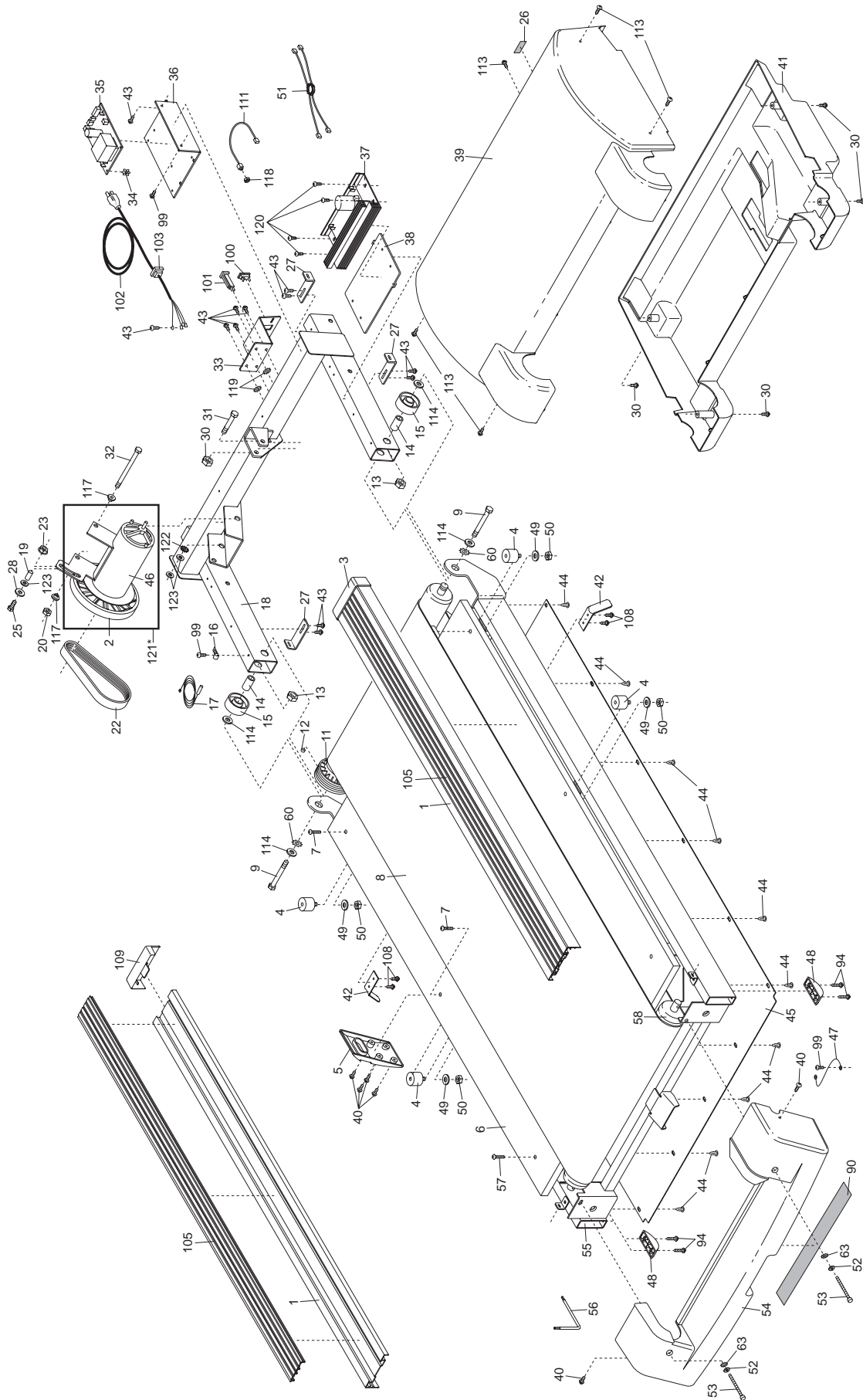

EXPLODED DRAWING—Model No. PFTL71330

R0803A

